



Main

Range of product	Harmony XB4
Product or component type	Complete illuminated double-headed pushbutton
Device short name	XB4
Bezel material	Chromium plated metal
Fixing collar material	Zamak
Mounting diameter	22 mm
Shape of signaling unit head	Rectangular
Type of operator	Spring return
Operator profile	1 flush - 1 projecting pushbuttons - 1 central pilot light
Operators description	Green "I" - red "O"
Contacts type and composition	1 NO + 1 NC
Contacts operation	Slow-break
Connections - terminals	Screw clamp terminals: $\geq 1 \times 0.22 \text{ mm}^2$ without cable end conforming to EN/IEC 60947-1 Screw clamp terminals: $\leq 2 \times 1.5 \text{ mm}^2$ with cable end conforming to EN/IEC 60947-1
Light source	Protected LED
Bulb base	Integral LED
[Us] rated supply voltage	110...120 V AC, 50/60 Hz

Complementary

Product weight	0.13 kg
Resistance to high pressure washer	7000000 Pa at 55 °C, distance: 0.1 m
Colour of marking	Black marking when white caps White marking when green, red or black caps
Operator profile	Red projecting, white O Green flush, white I
Contacts usage	Standard contacts
Positive opening	With positive opening conforming to EN/IEC 60947-5-1 appendix K
Operating travel	4.3 mm (total travel) 2.6 mm (NO changing electrical state) 1.5 mm (NC changing electrical state)
Operating force	3.8 N (NO changing electrical state) 3.5 N (NC changing electrical state)
Mechanical durability	1000000 cycles
Tightening torque	0.8...1.2 N.m conforming to EN 60947-1
Shape of screw head	Slotted head compatible with flat Ø 5.5 mm screwdriver Slotted head compatible with flat Ø 4 mm screwdriver Cross head compatible with pozidriv No 1 screwdriver Cross head compatible with Philips no 1 screwdriver Cross head compatible with JIS No 1 screwdriver
Contacts material	Silver alloy (Ag/Ni)
Short circuit protection	10 A cartridge fuse type gG conforming to EN/IEC 60947-5-1
[Ith] conventional free air thermal current	10 A conforming to EN/IEC 60947-5-1
[Ui] rated insulation voltage	600 V (degree of pollution: 3) conforming to EN 60947-1
[Uimp] rated impulse withstand voltage	6 kV conforming to EN 60947-1

The information provided in this documentation contains general descriptions and/or technical characteristics of the performance of the products contained herein. This documentation is not intended as a substitute for and is not to be used for determining suitability or reliability of these products for specific user applications. It is the duty of any such user or integrator to perform the appropriate and complete risk analysis, evaluation and testing of the products with respect to the relevant specific application or use thereof. Neither Schneider Electric Industries SAS nor any of its affiliates or subsidiaries shall be responsible or liable for misuse of the information contained herein.

[I _e] rated operational current	1.2 A at 600 V, AC-15, A600 conforming to EN/IEC 60947-5-1 0.55 A at 125 V, DC-13, Q600 conforming to EN/IEC 60947-5-1 0.27 A at 250 V, DC-13, Q600 conforming to EN/IEC 60947-5-1 0.1 A at 600 V, DC-13, Q600 conforming to EN/IEC 60947-5-1 6 A at 120 V, AC-15, A600 conforming to EN/IEC 60947-5-1 3 A at 240 V, AC-15, A600 conforming to EN/IEC 60947-5-1
Electrical durability	1000000 cycles, DC-13, 0.5 A at 24 V, operating rate: 3600 cyc/h, load factor: 0.5 conforming to EN/IEC 60947-5-1 appendix C 1000000 cycles, DC-13, 0.2 A at 110 V, operating rate: 3600 cyc/h, load factor: 0.5 conforming to EN/IEC 60947-5-1 appendix C 1000000 cycles, AC-15, 4 A at 24 V, operating rate: 3600 cyc/h, load factor: 0.5 conforming to EN/IEC 60947-5-1 appendix C 1000000 cycles, AC-15, 3 A at 120 V, operating rate: 3600 cyc/h, load factor: 0.5 conforming to EN/IEC 60947-5-1 appendix C 1000000 cycles, AC-15, 2 A at 230 V, operating rate: 3600 cyc/h, load factor: 0.5 conforming to EN/IEC 60947-5-1 appendix C
Electrical reliability IEC 60947-5-4	$\Lambda < 10\exp(-8)$ at 17 V, 5 mA in clean environment conforming to EN/IEC 60947-5-4 $\Lambda < 10\exp(-6)$ at 5 V, 1 mA in clean environment conforming to EN/IEC 60947-5-4
Signalling type	Steady
Light source colour	White
Current consumption	14 mA
Service life	100000 h at rated voltage and 25 °C
Surge withstand	1 kV conforming to IEC 61000-4-5

Environment

Protective treatment	TH
Ambient air temperature for storage	-40...70 °C
Ambient air temperature for operation	-25...70 °C
Class of protection against electric shock	Class I conforming to IEC 60536
IP degree of protection	IP69 K conforming to IEC 60529 IP66 conforming to IEC 60529
NEMA degree of protection	NEMA 4X NEMA 13
IK degree of protection	IK05 conforming to IEC 50102
Standards	CSA C22-2 No 14 EN/IEC 60947-1 EN/IEC 60947-5-1 EN/IEC 60947-5-4 EN/IEC 60947-5-5 JIS C 4520 UL 508
Product certifications	BV CSA DNV GL LROS (Lloyds register of shipping) RINA UL listed
Vibration resistance	5 gn (f = 2...500 Hz) conforming to IEC 60068-2-6
Shock resistance	50 gn for 11 ms half sine wave acceleration conforming to IEC 60068-2-27 30 gn for 18 ms half sine wave acceleration conforming to IEC 60068-2-27
Resistance to fast transients	2 kV conforming to IEC 61000-4-4
Resistance to electromagnetic fields	10 V/m conforming to IEC 61000-4-3
Resistance to electrostatic discharge	8 kV in free air (in insulating parts) conforming to IEC 61000-4-2 6 kV on contact (on metal parts) conforming to IEC 61000-4-2
Electromagnetic emission	Class B conforming to IEC 55011

Dimensions of Pushbuttons

Pushbuttons, Spring Return

XB4 BA••

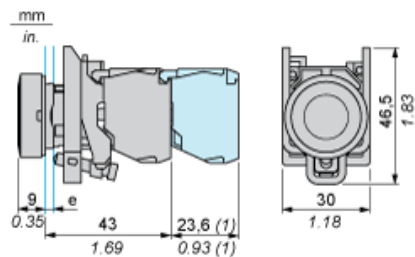

e: clamping thickness: 1 to 6 mm / 0.04 to 0.24 in.
(1) Additional row of contacts or double contact.

XB4 BL••

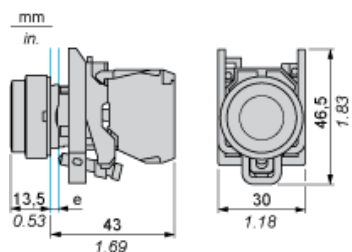

e: clamping thickness: 1 to 6 mm / 0.04 to 0.24 in.

XB4 BP••

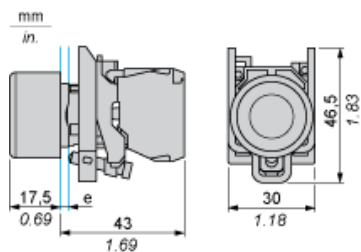

e: clamping thickness: 1 to 6 mm / 0.04 to 0.24 in.

Mushroom Head Pushbuttons, Spring Return

XB4 BC21

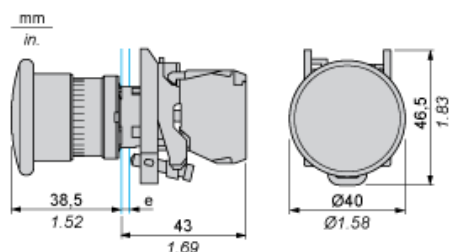

e: clamping thickness: 1 to 6 mm / 0.04 to 0.24 in.

Multiple-Headed Pushbuttons (Double or Triple), Spring Return

XB4 BL73415, XB4 BW73731•5

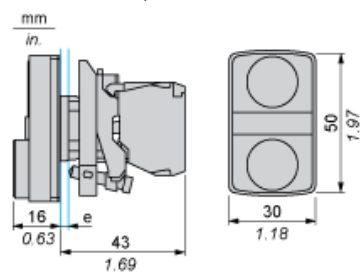

XB4 BA731327, XB4 BA711237

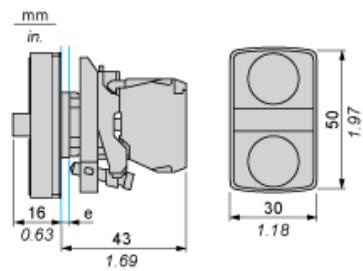

e: clamping thickness: 1 to 6 mm / 0.04 to 0.24 in.

Panel Cut-out for Pushbuttons, Switches and Pilot Lights (Finished Holes, Ready for Installation)

Connection by Screw Clamp Terminals or Plug-in Connectors or on Printed Circuit Board	Connection by Faston Connectors
	
<p>(1) Diameter on finished panel or support (2) 40 mm min. / 1.57 in. min. (3) 30 mm min. / 1.18 in. min. (4) $\varnothing 22.5 \text{ mm}$ / 0.89 in. recommended ($\varnothing 22.3 \text{ mm}_0^{+0.4}$ / $0.88 \text{ in.}_0^{+0.016}$) (5) 45 mm min. / 1.78 in. min. (6) 32 mm min. / 1.26 in. min.</p>	

Pushbuttons, Switches and Pilot Lights for Printed Circuit Board Connection

Panel Cut-outs (Viewed from Installer's Side)

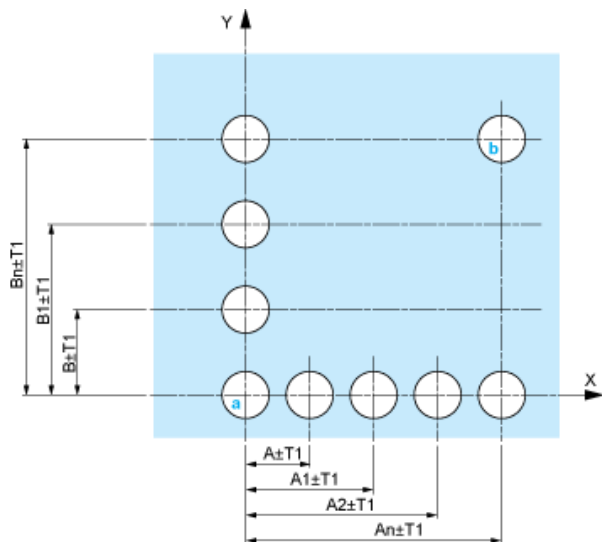

- A: 30 mm min. / 1.18 in. min.
 B: 40 mm min. / 1.57 in. min.

Printed Circuit Board Cut-outs (Viewed from Electrical Block Side)

Dimensions in mm



A: 30 mm min.

B: 40 mm min.

Dimensions in in.

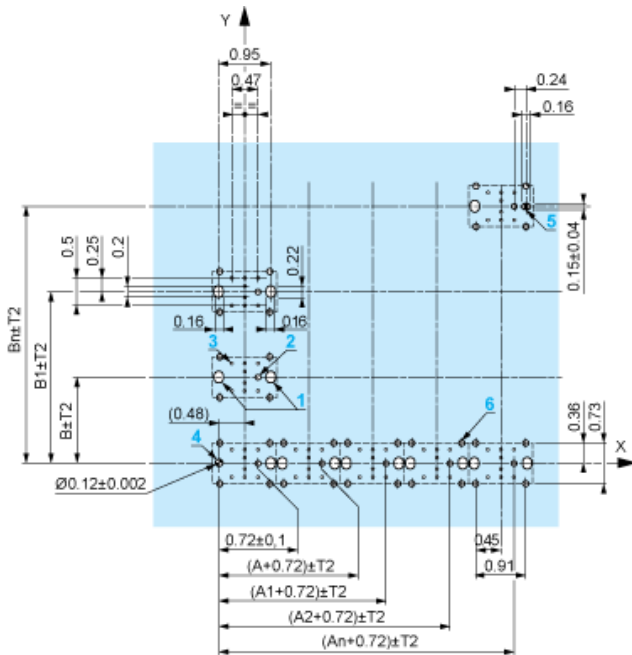

A: 1.18 in. min.

B: 1.57 in. min.

General Tolerances of the Panel and Printed Circuit Board

The cumulative tolerance must not exceed 0.3 mm / 0.012 in: $T1 + T2 = 0.3 \text{ mm max.}$

Installation Precautions

- Minimum thickness of circuit board: 1.6 mm / 0.06 in.
- Cut-out diameter: 22.4 mm \pm 0.1 / 0.88 in. \pm 0.004
- Orientation of body/fixing collar ZB4 BZ009: $\pm 2^\circ 30'$ (excluding cut-outs marked a and b).
- Tightening torque of screws ZBZ 006: 0.6 N.m (5.3 lbf.in) max.
- Allow for one ZB4 BZ079 fixing collar/pillar and its fixing screws:
 - every 90 mm / 3.54 in. horizontally (X), and 120 mm / 4.72 in. vertically (Y).
 - with each selector switch head (ZB4 BD•, ZB4 BJ•, ZB4 BG•).

The fixing centers marked a and b are diagonally opposed and must align with those marked 4 and 5.



- (1) Panel
(2) Printed circuit board

Mounting of Adapter (Socket) ZBZ 01•

- 1 2 elongated holes for ZBZ 006 screw access
- 2 1 hole $\varnothing 2.4 \text{ mm} \pm 0.05 / 0.09 \text{ in.} \pm 0.002$ for centring adapter ZBZ 01•
- 3 $8 \times \varnothing 1.2 \text{ mm} / 0.05 \text{ in.}$ holes
- 4 1 hole $\varnothing 2.9 \text{ mm} \pm 0.05 / 0.11 \text{ in.} \pm 0.002$, for aligning the printed circuit board (with cut-out marked a)
- 5 1 elongated hole for aligning the printed circuit board (with cut-out marked b)
- 6 4 holes $\varnothing 2.4 \text{ mm} / 0.09 \text{ in.}$ for clipping in adapter ZBZ 01•

Dimensions An + 18.1 relate to the $\varnothing 2.4 \text{ mm} \pm 0.05 / 0.09 \text{ in.} \pm 0.002$ holes for centring adapter ZBZ 01•.