



Contactor,37kW/400V,AC operated

EATON

Powering Business Worldwide™

Part no. DILM80(110V50HZ,120V60HZ)

Article no. 239399

Delivery programme

Product range			Contactors
Application			Contactors for Motors
Subrange			Contactors up to 170 A, 3 pole
Utilization category			AC-1: Non-inductive or slightly inductive loads, resistance furnaces AC-3: Squirrel-cage motors: starting, switching off during running AC-4: Squirrel-cage motors: starting, plugging, reversing, inching
Connection technique			Screw terminals
Pole			3 pole
Rated operational current			
AC-3			
380 V 400 V	I_e	A	80
AC-1			
Conventional free air thermal current, 3 pole, 50 - 60 Hz			
Open			
at 40 °C	$I_{th} = I_e$	A	110
at 50 °C	$I_{th} = I_e$	A	98
at 55 °C	$I_{th} = I_e$	A	94
at 60 °C	$I_{th} = I_e$	A	90
enclosed	I_{th}	A	80
Conventional free air thermal current, 1 pole			
open	I_{th}	A	225
enclosed	I_{th}	A	200
Max. rating for three-phase motors, 50 - 60 Hz			
AC-3			
220 V 230 V	P	kW	25
380 V 400 V	P	kW	37
660 V 690 V	P	kW	63
AC-4			
220 V 230 V	P	kW	11.5
380 V 400 V	P	kW	19
660 V 690 V	P	kW	26
Contact sequence			
Instructions			Contacts to EN 50012.
Can be combined with auxiliary contact			DILM150-XHI(V).. DILM1000-XHI(V)..
Voltage AC/DC			AC operation

Approbationen

UL approval	Yes
CSA approval	Yes
Product Standards	IEC/EN 60947-4-1; UL 508; CSA-C22.2 No. 14-05; CE marking
UL File No.	E29096
UL CCN	NLDX
CSA File No.	012528
CSA Class No.	2411-03, 3211-04
NA Certification	UL listed, CSA certified
Specially designed for NA	No

General

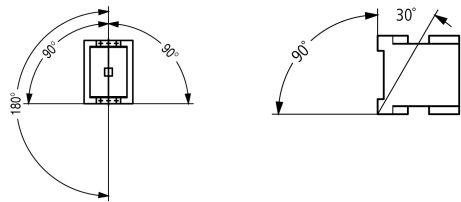
Standards			IEC/EN 60947, VDE 0660, UL, CSA
Lifespan, mechanical			
AC operated	Operations	x 10 ⁶	10
DC operated	Operations	x 10 ⁶	10
Operating frequency, mechanical			
AC operated	Operations/ h		3600
DC operated	Operations/ h		3600
Climatic proofing			Damp heat, constant to IEC 60068-2-78 Damp heat, cyclic to IEC 60068-2-30
Ambient temperature		°C	
Open		°C	- 25 - 60
Enclosed		°C	- 25 - 40
Storage		°C	- 40 - 80
Mounting position, AC- and DC operated			
Mechanical shock resistance (IEC/EN 60068-2-27)			
Half-sinusoidal shock, 10 ms			
Main contacts			
N/O contact	N/O contact	g	10
Auxiliary contacts			
N/O contact	N/O contact	g	7
N/C contact	N/C contact	g	5
Mechanical shock resistance (IEC/EN 60068-2-27) when tabletop-mounted			
Half-sinusoidal shock, 10 ms			
Main contacts			
N/O contact	N/O contact	g	10
Auxiliary contacts			
N/O contact	N/O contact	g	7
N/C contact	N/C contact	g	5
Protection type			IP00
Protection against direct contact when actuated from front (EN 50274)			Finger- and back-of-hand proof
Weight			
AC operated		kg	2
DC operated		kg	2.1
Terminal capacity main cable			
Flexible with ferrule		mm ²	1 x (10 - 95) 2 x (10 - 70)
Stranded		mm ²	1 x (16 - 95) 2 x (16 - 70)
Solid or stranded		AWG	8...3/0
Flat conductor	Number of segments x width x thickness	mm	2 x (6 x 16 x 0.8)
Main cable connection screw/bolt			M10
Tightening torque		Nm	14
Terminal capacity control circuit cables			
Solid		mm ²	1 x (0.75 - 4) 2 x (0.75 - 4)
Flexible with ferrule		mm ²	1 x (0.75 - 2.5) 2 x (0.75 - 2.5)

Solid or stranded		AWG	18 - 14
Control circuit cable connection screw/bolt			M3.5
Tightening torque		Nm	1.2
Tool			
Main cable			
Hexagon socket-head spanner	SW	mm	5
Control circuit cables			
Pozidriv screwdriver		Size	2
Standard screwdriver		mm	0.8 x 5.5 1 x 6
Terminal capacity control circuit cables			
Solid		mm ²	1 x (0.75 - 2.5) 2 x (0.75 - 2.5)
Flexible		mm ²	1 x (0.75 - 2.5) 2 x (0.75 - 2.5)
Flexible with ferrule		mm ²	1 x (0.75 - 1.5) 2 x (0.75 - 1.5)
Solid or stranded		AWG	18 - 14
Tool			
Stripping length		mm	10
Screwdriver blade width		mm	3.5

Main conducting paths

Rated impulse withstand voltage	U_{imp}	V AC	8000
Overvoltage category/pollution degree			III/3
Rated insulation voltage	U_i	V AC	690
Rated operational voltage	U_e	V AC	690
Safe isolation to VDE 0106 Part 101 and Part 101/A1			
between coil and contacts		V AC	690
between the contacts		V AC	690
Making capacity (p.f. to IEC/EN 60947)			
	Up to 690 V	A	1120
Breaking capacity			
220/230 V		A	800
380/400 V		A	800
500 V		A	800
660/690 V		A	650
Short-circuit rating			
Short-circuit protection maximum fuse			
Type "2" coordination			
400 V	gG/gL 500 V	A	160
690 V	gG/gL 690 V	A	160
Type "1" coordination			
400 V	gG/gL 500 V	A	250
690 V	gG/gL 690 V	A	200

AC

AC-1			
Rated operational current			
Conventional free air thermal current, 3 pole, 50 - 60 Hz			
Open			
at 40 °C	$I_{th} = I_e$	A	110
at 50 °C	$I_{th} = I_e$	A	98

at 55 °C	$I_{th}=I_e$	A	94
at 60 °C	$I_{th}=I_e$	A	90
enclosed	I_{th}	A	80
Conventional free air thermal current, 1 pole			
open	I_{th}	A	225
enclosed	I_{th}	A	200
AC-3			
Rated operational current			
offen, 3-polig, 50 - 60 Hz			
220 V 230 V	I_e	A	80
240 V	I_e	A	80
380 V 400 V	I_e	A	80
415 V	I_e	A	80
440V	I_e	A	80
500 V	I_e	A	80
660 V 690 V	I_e	A	65
Motor rating			
220/230 V	P	kWh	25
240V	P	kW	27.5
380/400 V	P	kW	37
415 V	P	kW	48
440 V	P	kW	51
500 V	P	kW	58
660/690 V	P	kW	63
AC-4			
offen, 3-polig, 50 - 60 Hz			
220/230 V	I_e	A	40
240 V	I_e	A	40
380/400 V	I_e	A	40
415 V	I_e	A	40
440 V	I_e	A	40
500 V	I_e	A	40
660/690 V	I_e	A	27
Motor rating			
220/230 V	P	kWh	11.5
240 V	P	kW	13
380/400 V	P	kW	19
415 V	P	kW	24
440 V	P	kW	25
500 V	P	kW	29
660/690 V	P	kW	26

DC

Rated operational current, open			
DC-1			
60 V	I_e	A	110
110 V	I_e	A	110
220 V	I_e	A	70
440 V	I_e	A	4.5
DC-3			
60 V	I_e	A	110
110 V	I_e	A	110
220 V	I_e	A	35
440 V	I_e	A	1

DC-5			
60 V	I_e	A	110
110 V	I_e	A	110
220 V	I_e	A	35
440 V	I_e	A	1

Current heat loss

3-pole at I_{th}		W	12.2
Current heat loss at I_e to AC-3/400 V		W	9.6
Impedance per pole		m Ω	0.5

Magnet systems

Voltage tolerance		$\times U_c$	
AC operated	Pick-up	$\times U_c$	0.8 - 1.1
Drop-out voltage AC operated	Drop-out	$\times U_c$	0.3 - 0.6
DC operated	Pick-up	$\times U_c$	0.7 - 1.2
Notes			at least smoothed two-phase bridge rectifier or three-phase rectifier
DC operated	Drop-out	$\times U_c$	0.15 - 0.6
Power consumption of the coil in a cold state and $1.0 \times U_c$			
50 Hz	Pick-up	VA	310
50 Hz	Sealing	VA	26
50 Hz	Sealing	W	5.8
60 Hz	Pick-up	VA	345
60 Hz	Sealing	VA	30
60 Hz	Sealing	W	7.1
50/60 Hz	Pick-up	VA	372 328
50/60 Hz	Sealing	VA	37.1 22.6
50/60 Hz	Sealing	W	7.5 6.1
DC operated	Pick-up	W	90
DC operated	Sealing	W	1.3
Duty factor		% DF	100
Switching times at 100 % U_c (approximate values)			
Main contacts			
AC operated			
Closing delay		ms	14 - 20
Opening delay		ms	9 - 14
DC operated		ms	
Closing delay		ms	45
Opening delay		ms	34
Arcing time		ms	15
Permissible residual current with actuation of A1 - A2 by the electronics (with 0 signal).		mA	≤ 1
Lifespan, mechanical; Coil 50/60 Hz	at 50 Hz		Mechanical lifespan at 50 Hz approx. 30% lower than under "General"

Electromagnetic compatibility (EMC)

Emitted interference			to EN 60947-1
Interference immunity			to EN 60947-1

Technical data ETIM 4.0

Number of main contacts as N/Os			3
Rated operation current I_e at AC-1, 400 V			110
Connection type main circuit			Screw connection
Rated control voltage U_s at AC 60HZ		V	120
Number of auxiliary contacts as N/Os			0
Rated control voltage U_s at AC 50HZ		V	110
Number of auxiliary contacts as N/Cs			0

Suitable for rail-mounting		No
Rated control voltage U_s at DC	V	0
Voltage type for actuation		AC
Rated operation current I_e at AC-3, 400 V	A	80
Number of N/Cs as main contact		0
Motor rating at AC-3, 400 V	kWh	37

Characteristics

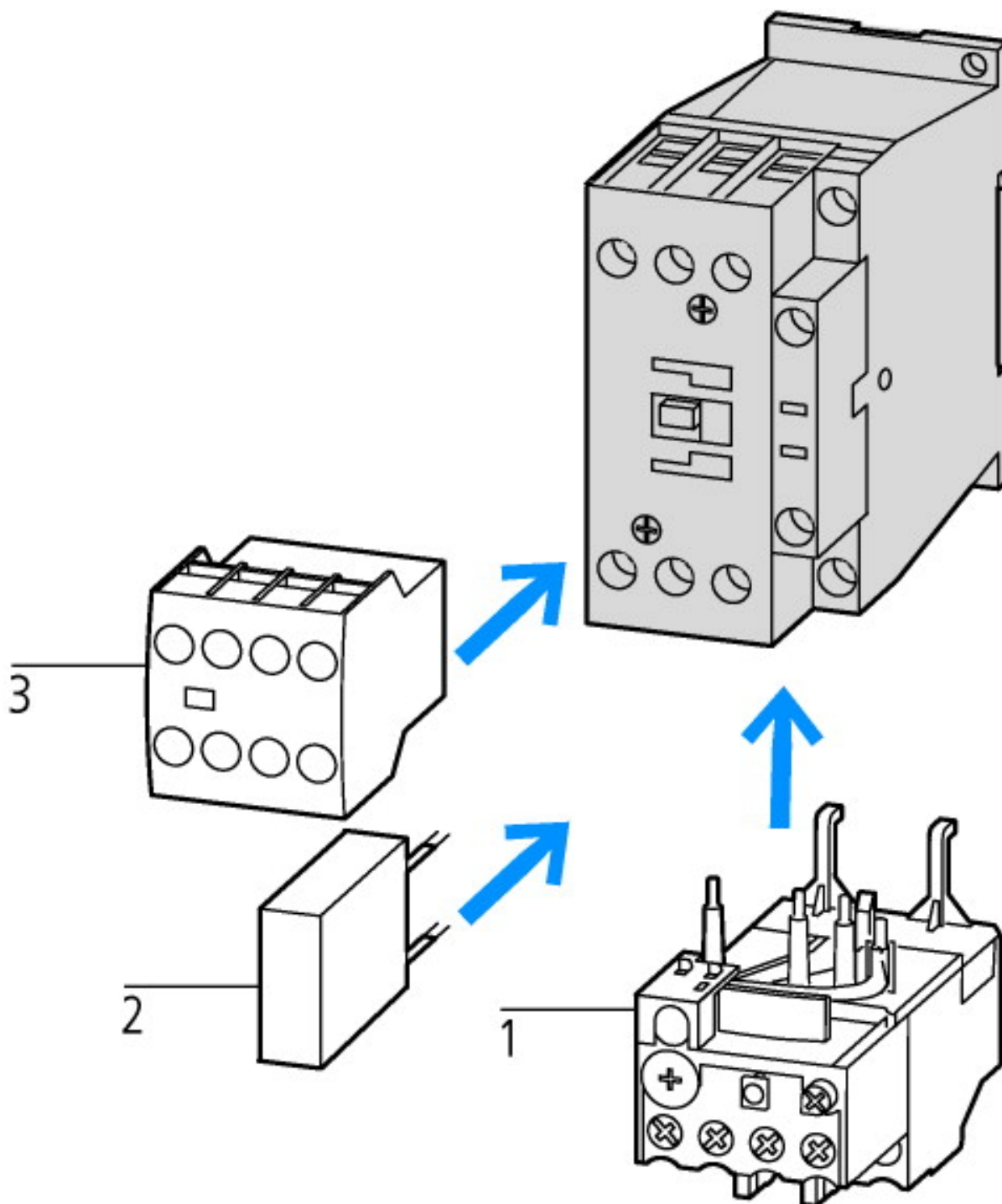

- 1: Overload relay
- 2: Suppressor
- 3: Auxiliary contact modules

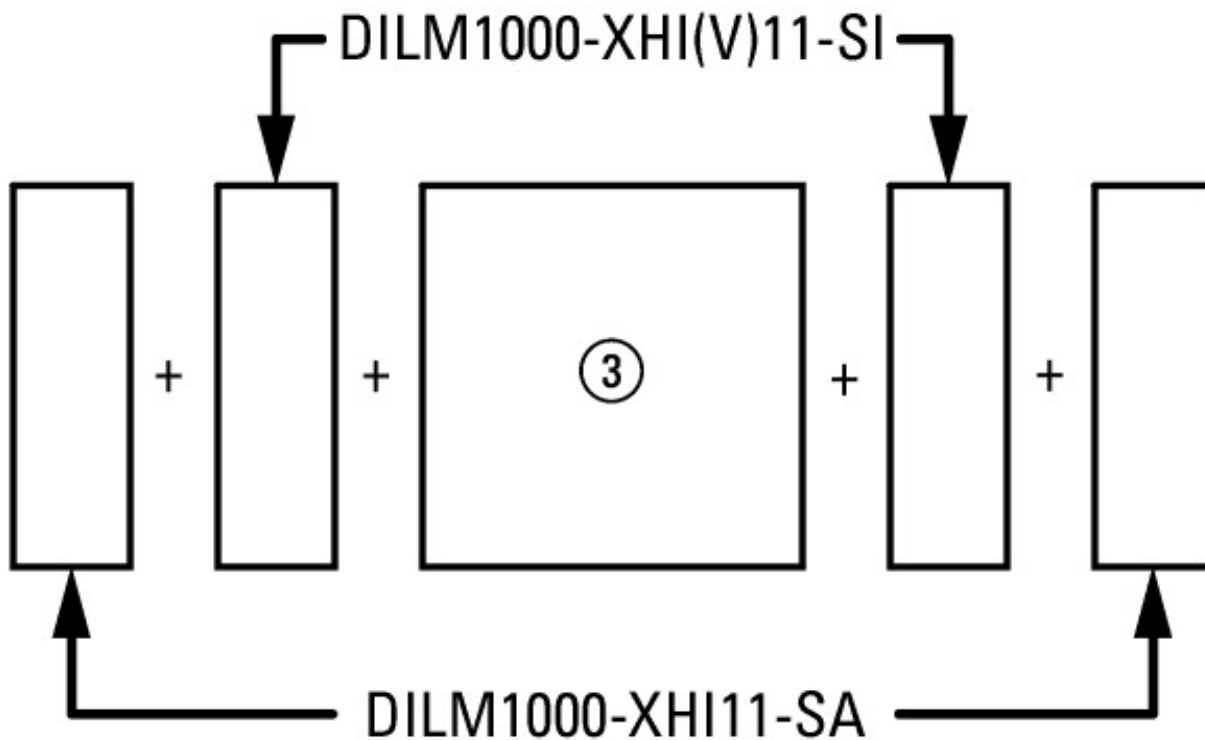

on the side: 2 x DILM820-XHI(V)11-SI; 2 x DILM820-XHI(V)11-SA
 on the side: 2 x DILM1000-XHI(V)11-SI; surface mounting: 1 x DILM150-XHIA22
 on the side: 2 x DILM1000-XHI(V)11-SI; surface mounting: 1 x DILM150-XHIA11
 on the side: 2 x DILM1000-XHI(V)11-SA; surface mounting: 1 x DILM150-XHI (4 pole)
 on the side: 2 x DILM1000-XHI(V)11-SA; surface mounting: 1 x DILM150-XHI (2 pole)

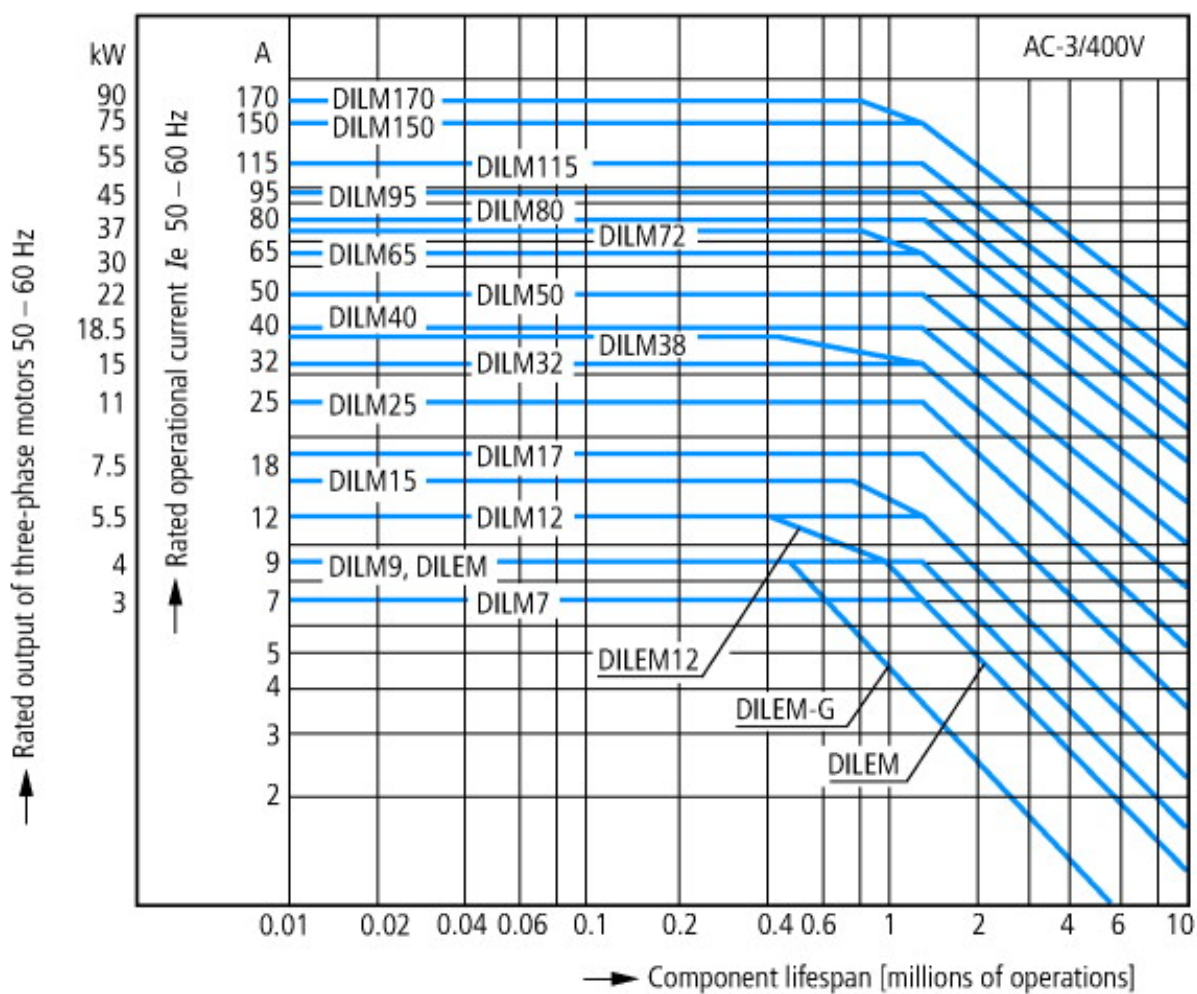

Squirrel-cage motor
 Operating characteristics
 Starting: from rest
 Stopping: after attaining full running speed
 Electrical characteristics
 Make: up to 6 x rated motor current
 Break: up to 1 x rated motor current
 Utilization category
 100 % AC-3
 Typical applications
 Compressors
 Lifts
 Mixers
 Pumps
 Escalators
 Agitators
 Fans
 Conveyor belts
 Centrifuges
 Hinged flaps
 Bucket-elevators
 Air conditioning system
 General drives in manufacturing and processing machines

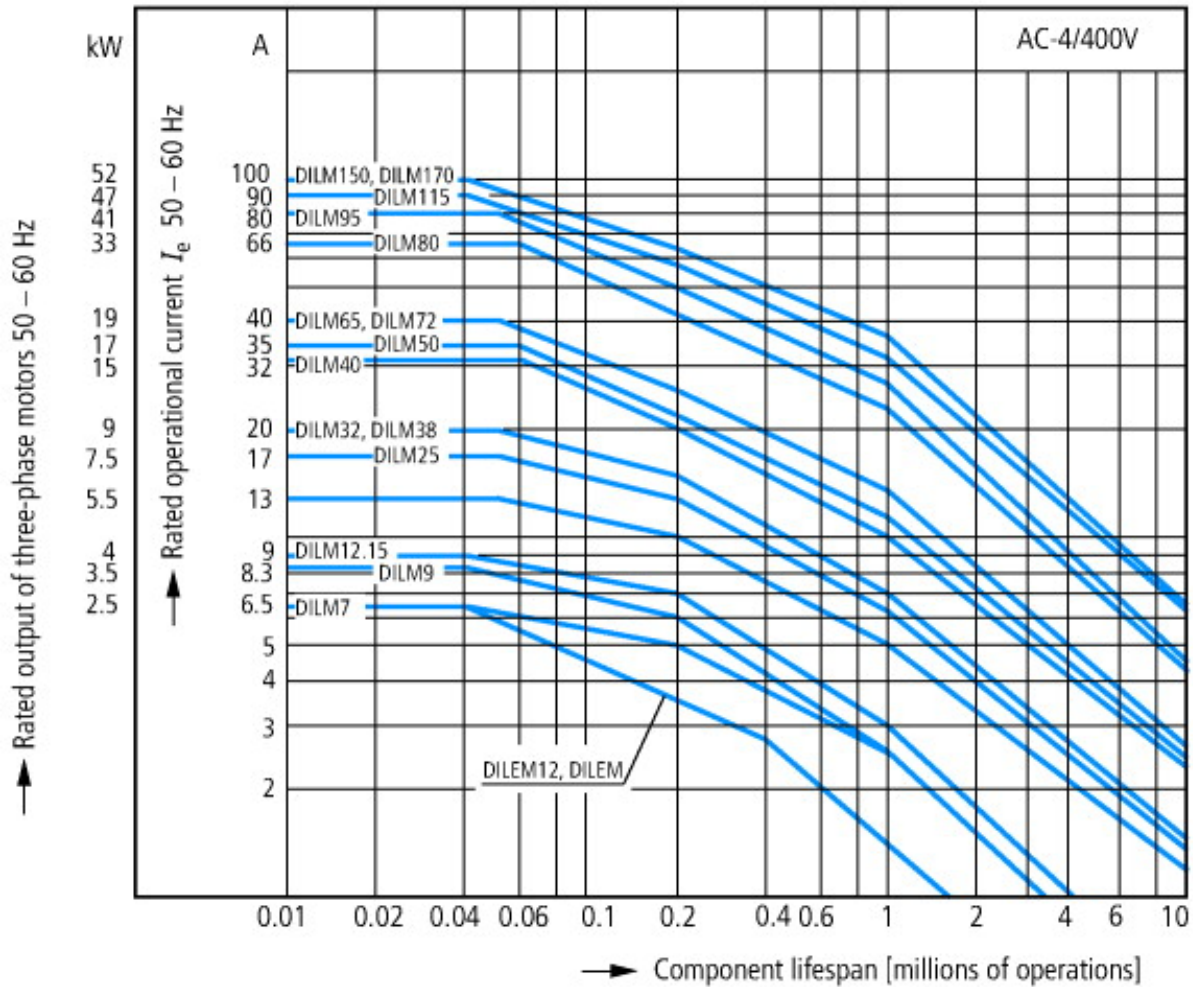

Extreme switching duty
 Squirrel-cage motor
 Operating characteristics
 Inching, plugging, reversing
 Electrical characteristics
 Make: up to 6 x rated motor current
 Break: up to 6 x rated motor current
 Utilization category
 100 % AC-4
 Typical applications
 Printing presses
 Wire-drawing machines
 Centrifuges
 Special drives for manufacturing and processing machines

Dimensions

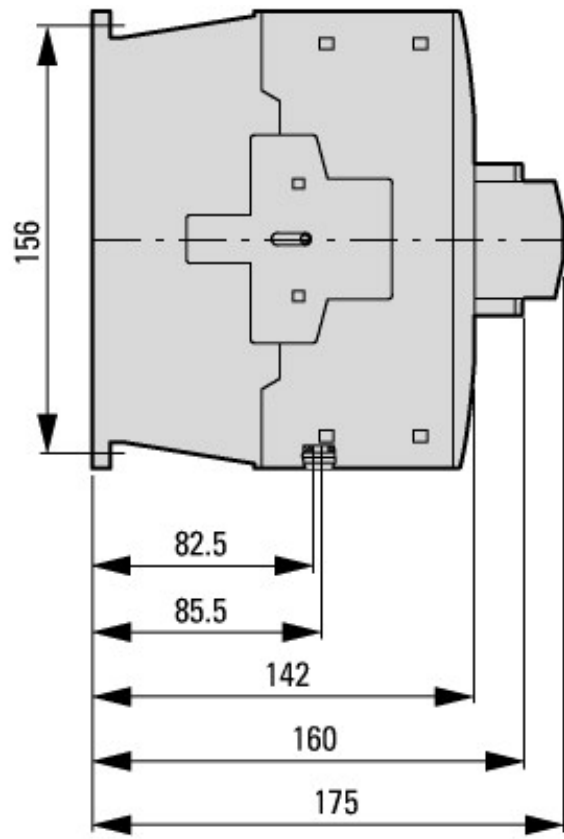
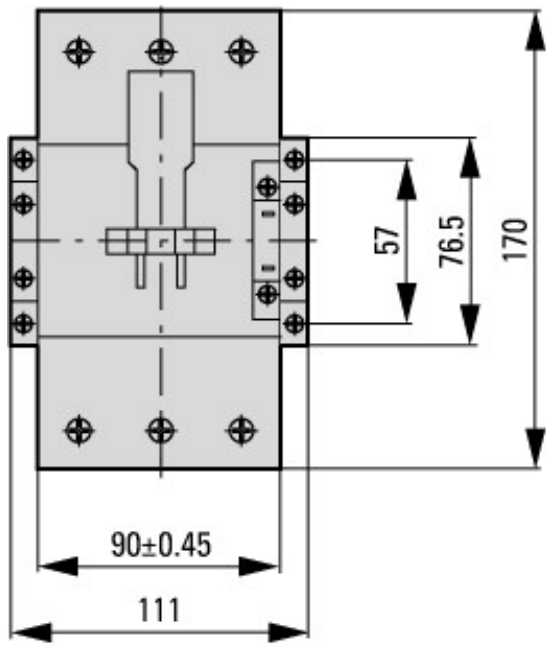

Contacteur avec module de contact auxiliaire

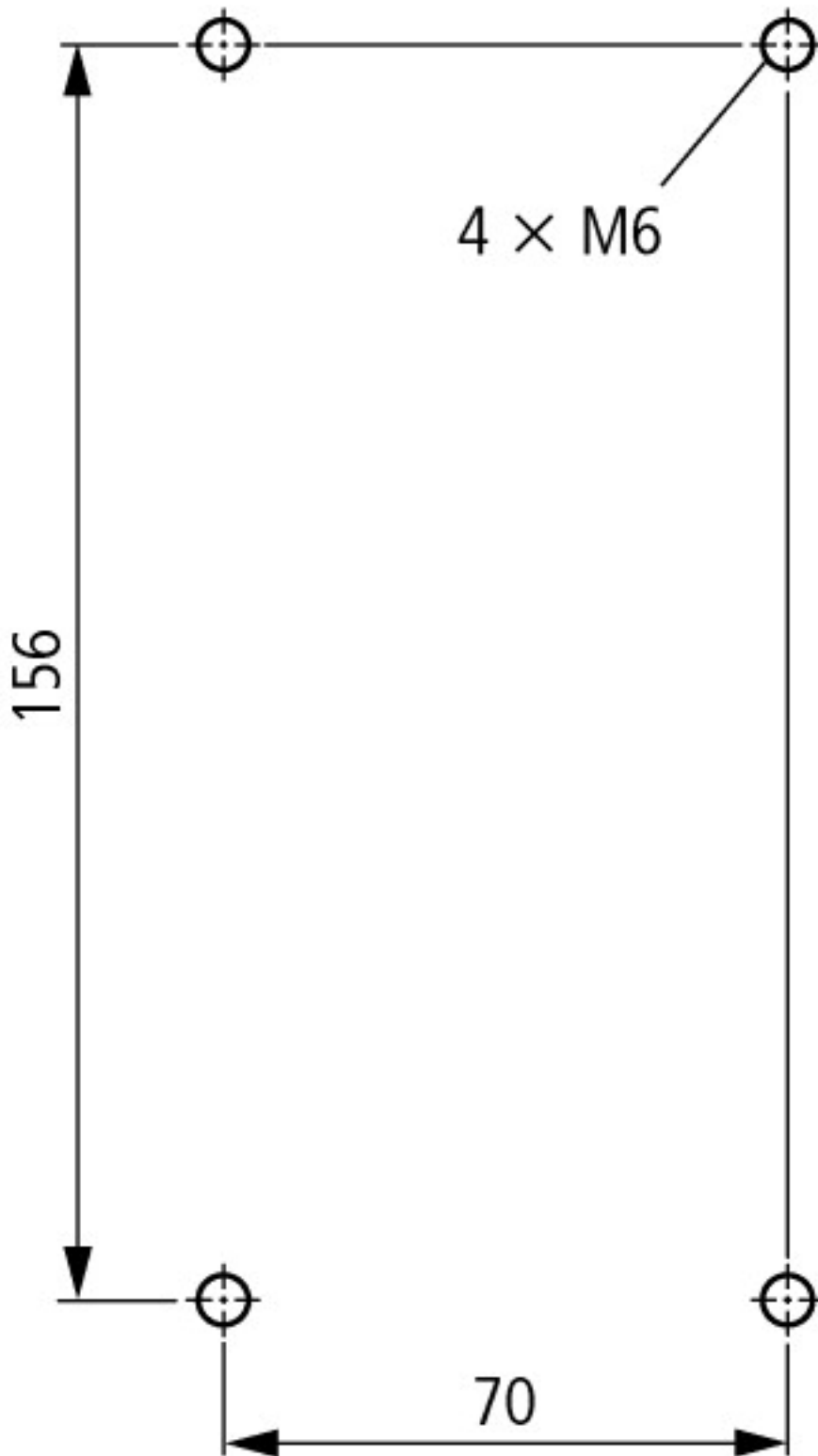

distance at side to earthed parts: 10 mm

DILM80...DILM170
 DILMC80...DILMC150
 DILMF80...DILMF150

Additional product information (links)

IL03407039Z (AWA2100-2286) Contactors

IL03407039Z (AWA2100-2286)
 Contactors

ftp://ftp.moeller.net/DOCUMENTATION/AWA_INSTRUCTIONS/IL03407039Z2010_10.pdf

<http://de.ecat.moeller.net/flip-cat/?edition=HPLTE&startpage=5.84>

<http://de.ecat.moeller.net/flip-cat/?edition=HPLTE&startpage=5.85>

<http://de.ecat.moeller.net/flip-cat/?edition=HPLTE&startpage=5.86>

Switchgear of Power Factor Correction
 Systems

http://www.moeller.net/binary/ver_techpapers/ver934en.pdf

X-Start - New Generation:100 years
 of Moeller contactors - Continous
 Progress-

http://www.moeller.net/binary/ver_techpapers/ver937en.pdf

X-Start - Modern Switching Installations Efficiently Fitted and Wired Securely	http://www.moeller.net/binary/ver_techpapers/ver938en.pdf
Mirror Contacts for Highly-Reliable Information Relating to Safety-Related Control Functions	http://www.moeller.net/binary/ver_techpapers/ver944en.pdf
Effect of the Cabel Capacitance of Long Control Cables on the Actuation of Contactors	http://www.moeller.net/binary/ver_techpapers/ver949en.pdf
Motor starters and "Special Purpose Ratings" for the North American market	http://www.moeller.net/binary/ver_techpapers/ver953en.pdf
Switchgear for Luminaires	http://www.moeller.net/binary/ver_techpapers/ver955en.pdf
Standard Compliant and Functionally Safe Engineering Design with Mechanical Auxiliary Contacts	http://www.moeller.net/binary/ver_techpapers/ver956en.pdf
The Interaction of Contactors with PLCs	http://www.moeller.net/binary/ver_techpapers/ver957en.pdf
Busbar Component Adapters for modern Industrial control panels	http://www.moeller.net/binary/ver_techpapers/ver960en.pdf