



## Control relay, 24 V DC, relay output



Powering Business Worldwide™

Part no.

EASY820-DC-RC

Article no.

256271

### Delivery programme

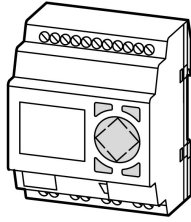
			
Product range			Control relays easyRelay
Basic function			easy800 (expandable, easyNet)
Description			erweiterbar: Digital-Ein-/Ausgänge, Bussysteme AS-Interface, PROFIBUS-DP, CANopen®, DeviceNet Bus system easyNet on board Customized laser inscription or delivery with user program possible with EASY-COMBINATION-* product (article No. 257823)
Inputs			
Digital input count			digital: 12 digital: 12; of which can be used as analog: 4
Digital			12
of which can be used as analog			4
Outputs			
Type			Relay Analog
Quantity of outputs			Relays: 6 Relays: 6; analog: 1
Outputs		Number	7
Additional features			
Display			with display, with keypad
Expansions			Expandable Networkable (easyNet)
Supply voltage			24 V DC
Software			EASY-SOFT-PRO

### Approbationen

UL approval  
CSA approval  
Product Standards

Yes

Yes

IEC/EN see Technical Data; UL 508; CSA C22.2 No. 142-M1987; CSA C22.2 No. 213-M1987; CE marking

UL File No.  
UL CCN  
CSA File No.  
CSA Class No.  
NA Certification  
Degree of Protection

E135462

NRAQ

012528

2252-01 + 2258-02

UL listed, CSA certified

IEC: IP20, UL/CSA Type: -

### General

Standards			EN 55011, EN 55022, IEC/EN 61000-4, IEC 60068-2-6, IEC 60068-2-27
Dimensions (W x H x D)		mm	107.5 x 90 x 72 (6 PE)
Weight		kg	0.3
Mounting			Top-hat rail IEC/EN 60715, 35 mm or screw fixing using fixing brackets ZB4-101-GF1 (accessories)

### Terminal capacities

Solid		mm <sup>2</sup>	0.2/4 (AWG 22 - 12)
Flexible with ferrule		mm <sup>2</sup>	0.2/2.5 (AWG 22 - 12)
Standard screwdriver		mm	3.5 x 0.8
Max. tightening torque		Nm	0.6

### Climatic environmental conditions

Operating ambient temperature		°C	In accordance with IEC 60068-2-1, -25 - +55
Condensation			Take appropriate measures to prevent condensation

LCD display (clearly legible)		°C	0 - 55
Storage		°C	In accordance with IEC 60068-2-1, -2, -14 -40 - +70
relative humidity		%	nach IEC 60068-2-30, IEC 600068-2-78 5 - 95
Air pressure (operation)		hPa	795 - 1080

### Ambient conditions, mechanical

Protection type (IEC/EN 60529, EN50178, VBG 4)			IP20
Vibrations		Hz	nach IEC 60068-2-6 konstante Amplitude 0.15 mm: 10 - 57 konstante Beschleunigung 2 g: 57 - 150
Mechanical shock resistance (IEC/EN 60068-2-27) semi-sinusoidal 15 g/11 ms		Impacts	18
Drop to IEC/EN 60068-2-31	Drop height	mm	50
Free fall, packaged (IEC/EN 60068-2-32)		m	1
Mounting position			Vertical or horizontal

### Electromagnetic compatibility (EMC)

Overvoltage category/pollution degree			III/2
Electrostatic discharge (ESD)			
applied standard			according to IEC EN 61000-4-2
Air discharge		kV	8
Contact discharge		kV	6
Electromagnetic fields (RFI), to IEC EN 61000-4-3		V/m	0.8 - 1.0 GHz: 10 1.4 - 2 GHz: 3 2.0 - 2.7 GHz: 1
Radio interference suppression			EN 55011 Class B
Burst			according to IEC/EN 61000-4-4
power pulses (Surge)			according to IEC/EN 61000-4-5 1 kV (supply cables, symmetrical)
Immunity to line-conducted interference to (IEC/EN 61000-4-6)		V	10

### Insulation resistance

Clearance in air and creepage distances			EN 50178, UL 508, CSA C22.2, No. 142
Insulation resistance			EN 50178

### Back-up of real-time clock

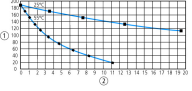
Back-up of real-time clock			
			<p>① Backup time (hours) with fully charged double layer capacitor</p> <p>② Service life (years)</p>
Accuracy of real-time clock to inputs		s/day	typ. $\pm 2$ ( $\pm 0.2$ h/Year)
			depending on ambient air temperature fluctuations of up to $\pm 5$ s/day ( $\pm 0.5$ h/year) are possible

### Repetition accuracy of timing relays







Accuracy of timing relays (of values)		%	$\pm 0.02$
Resolution			
Range "S"		ms	5
Range "M:S"		s	1
Range "H:M"		min	1

### Retentive memory

Write cycles of the retentive memory			$10^{12}$ (read/write cycles)
--------------------------------------	--	--	-------------------------------

### Power supply

Rated operational voltage	$U_e$	V	24 DC (-15/+20%)
Permissible range			20.4 - 28.8 V DC
Residual ripple		%	$\frac{\Delta U}{U} \leq 5$
Siemens MPI, (optional)			yes
Input current			140 mA at $U_e$
Einschaltstrom- und dauer		A	12.5 für 6 ms



Voltage dips		ms	≤In accordance with IEC 61131-2 ≤ 20
Fuse		A	 1A (T)
<b>Digital inputs 24 V DC</b>			
Number			12
Inputs can be used as analog inputs			4 (I7, I8, I11, I12)
Status Display			LCD-Display
Potential isolation			from power supply: no between digital inputs: no from the outputs: yes to interface/memory card: no to easyLink: no to easyNet: yes
Rated operational voltage	U <sub>e</sub>	V DC	24
Input voltage		V DC	Signal 0:  5 (I1 - I6, I9, I10,  8 (I7, I8, I11, I12) Signal 1:  15 (I1 - I6, I9, I10),  8 (I7, I8, I11, I12)
Input current at signal 1		mA	I1 - I6, I9, I10: 3.3 (at 24 V DC) I7, I8, I11, I12: 2.2 (at 24 V DC)
Deceleration time		ms	20 (0 -> 1/1 -> 0, Debounce ON) normally 0.025 (0 -> 1/1 -> 0, Debounce OFF, I1 - I4) normally 0.25 (0 -> 1/1 -> 0, Debounce OFF, I5, I6, I9, I10) normally 0.15 (0 -> 1/1 -> 0, Debounce OFF, I7, I8, I11, I12)
Cable length		m	100 (unshielded)
Frequency counter			
Number			4 (I1, I2, I3, I4)
Counter frequency		kHz	 5
Pulse shape			Square
Pulse pause ratio			1:1
Cable length		m	 20 (screened)
Incremental counter			
Number of counter inputs			2 (I1 + I2, I3 + I4)
Counter frequency		kHz	 3
Pulse shape			Square
Signal offset			90°
Pulse pause ratio			1:1
Rapid counter inputs			
Number			4 (I1, I2, I3, I4)
Cable length		m	 20 (screened)
Counter frequency		kHz	< 5
Pulse shape			Square
Pulse pause ratio			1:1
<b>Analog inputs</b>			
Number			4 (I7, I8, I11, I12)
Potential isolation			from power supply: no between digital inputs: no from the outputs: yes to interface/memory card: no to easyLink: no to easyNet: yes
Input type			DC voltage
Signal range			0-10 V DC
Resolution			0.01 V analog 0.01 V digital 10 Bit (value 0 - 1023)
Input impedance		kΩ	11.2
Accuracy of actual value			
Two EASY devices		%	± 3
Within a single device		%	± 2, (I7, I8, I11, I12) ± 0.12 V
Conversion time, analog/digital		ms	each CPU cycle

Input current		mA	< 1
Cable length		m	 30, screened

### Analog outputs

Number			1
Potential isolation			from power supply: no To the digital inputs: no From the digital outputs: yes to interface/memory card: yes to easyNet: yes to easyLink: yes
Output type			DC voltage
Signal range			0-10 V DC
Max. output current		A	0.01
Load resistance			1 kΩ
Overload and short-circuit protection			Yes
Resolution			0.01 V DC analog 10 Bit (value 0 - 1023) digital
Recovery time		μs	100
Accuracy			
-25 °C - 55 °C		%	2
25 °C		%	1
Conversion time, analog/digital		ms	each CPU cycle

### Relay outputs

Number			6
Outputs in groups of			1
Parallel switching of outputs for increased output			Not permissible
Protection of an output relay			Miniature circuit-breaker B16 or fuse 8 A (slow)
Potential isolation			from power supply: yes From the inputs: yes between digital inputs: yes to the interface: yes to easyLink: yes to easyNet: yes Safe isolation according to EN 50178: 300 V AC Basic isolation: 600 V AC
Lifespan, mechanical	Operations	x 10 <sup>6</sup>	10
Contacts			
Conventional thermal current (10 A UL)		A	8
Recommended for load: 12 V AC/DC		mA	> 500
Short-circuit-proof cos φ = 1, characteristic B16 at 600 A		A	16
Short-circuit-proof cos φ = 0.5 to 0.7, characteristic B16 at 900 A		A	16
Rated impulse withstand voltage U <sub>imp</sub> of contact coil		kV	6
Rated operational voltage	U <sub>e</sub>	V AC	250
Rated insulation voltage	U <sub>i</sub>	V AC	250
Safe isolation according to EN 50178		V AC	300 between coil and contact 300 between two contacts
Making capacity			
AC--15, 250 V AC, 3 A (600 ops./h)	Operations		300000
DC-13, L/R  150 ms, 24 V DC, 1 A (500 S/h)	Operations		200000
Breaking capacity			
AC-15, 250 V AC, 3 A (600 Ops./h)	Operations		300000
DC-13, L/R  150 ms, 24 V DC, 1 A (500 S/h)	Operations		200000
Filament bulb load			
1000 W at 230/240 V AC	Operations		25000
500 W at 115/120 V AC	Operations		25000
Fluorescent lamp load			
Fluorescent lamp load 10 x 58 W at 230/240 V AC			
With upstream electrical device	Operations		25000

Uncompensated	Operations		25000
Fluorescent lamp load 1 x 58 W at 230/240 V AC, conventional, compensated	Operations		25000
Switching frequency			
Mechanical operations		x 10 <sup>6</sup>	10
Switching frequency		Hz	10
Resistive load/lamp load		Hz	2
Inductive load		Hz	0.5
UL/CSA			
Uninterrupted current at 240 V AC		A	10
Uninterrupted current at 24 V DC		A	8
AC			
Control Circuit Rating Codes (utilization category)			B 300 Light Pilot Duty
Max. rated operational voltage		V AC	300
max. thermal continuous current cos φ = 1 at B 300		A	5
max. make/break cos φ ≠ capacity 1 at B 300		VA	3600/360
DC			
Control Circuit Rating Codes (utilization category)			R 300 Light Pilot Duty
Max. rated operational voltage		V DC	300
Max. thermal uninterrupted current at R 300		A	1
Max. make/break capacity at R 300		VA	28/28

## Netzwerk easyNet

Data transfer rate/distance			1000 KBit/s, 6 m 500 KBit/s, 25 m 250 Kbit/s, 40 m 125 Kbit/s, 300 m 50 KBit/s, 300 m 20 KBit/s, 700 m 10 KBit/s, 1000 m Lengths from 40 m can be obtained only with cables with reinforced cross-section and terminal adapter.
Potential isolation			from power supply POW: yes From the inputs: yes from the outputs: yes to easyLink: yes to the interface: yes
Bus termination (first and last station)			ja
Anschlusstechnik			RJ45, 8-polig
Terminal capacity			up to 1000 m, < 16 mΩ/m: 1.5 (AWG: 16) up to 600 m, < 26 mΩ/m: 0.75 - 0.8 (AWG: 18) up to 600 m, < 26 mΩ/m: 0.5 - 0.6 (AWG: 20, 19) up to 400 m, < 40 mΩ/m: 0.34 - 0.5 (AWG: 22, 21, 20) up to 250 m, < 60 mΩ/m: 0.25 - 0.34 (AWG: 23, 22) up to 175 m, < 70 mΩ/m: 0.13 (AWG: 26) up to 40 m, < 140 mΩ/m: 1.5 (AWG: 16)

## Dimensions

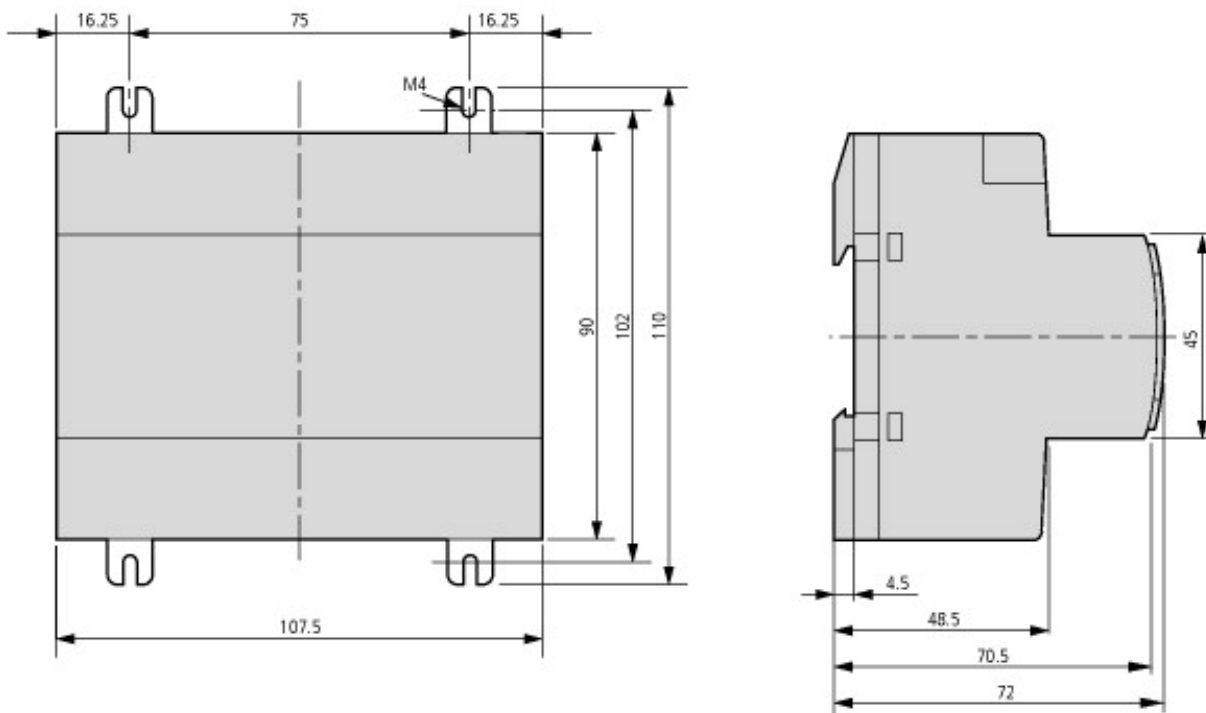

### Additional product information (links)

#### IL05013012Z (AWA2528-1979) Control relay easy

IL05013012Z (AWA2528-1979) Control relay easy

[ftp://ftp.moeller.net/DOCUMENTATION/AWA\\_INSTRUCTIONS/IL05013012Z2010\\_11.pdf](ftp://ftp.moeller.net/DOCUMENTATION/AWA_INSTRUCTIONS/IL05013012Z2010_11.pdf)

#### MN04902001Z-EN (AWB2528-1423) easy800 Control Relay

MN04902001Z-DE (AWB2528-1423) Steuerrelais easy800 - Deutsch

[ftp://ftp.moeller.net/DOCUMENTATION/AWB\\_MANUALS/MN04902001Z\\_DE.pdf](ftp://ftp.moeller.net/DOCUMENTATION/AWB_MANUALS/MN04902001Z_DE.pdf)

MN04902001Z-EN (AWB2528-1423) easy800 Control Relay - English

[ftp://ftp.moeller.net/DOCUMENTATION/AWB\\_MANUALS/MN04902001Z\\_EN.pdf](ftp://ftp.moeller.net/DOCUMENTATION/AWB_MANUALS/MN04902001Z_EN.pdf)

Labeleditor

[ftp://ftp.moeller.net/MFD/EASY-SOFT-PRO/labeleditor\\_206.exe](ftp://ftp.moeller.net/MFD/EASY-SOFT-PRO/labeleditor_206.exe)